

M12 male 0° / M8 female 0°

PVC 3x0.25 ye UL/CSA 1,5m

Male straight – female straight

M12 – M8, 3-pole

Art-No. 7005 - M12 Lite - (plastic hexagonal screw) on request

Art-No. 7005 - M8 Lite - (plastic hexagonal screw) on request

Plastic housings with good resistance against chemicals and oils.

The resistance to aggressive media should be individually tested for your application. Further details on request.

Further cable lengths on request.

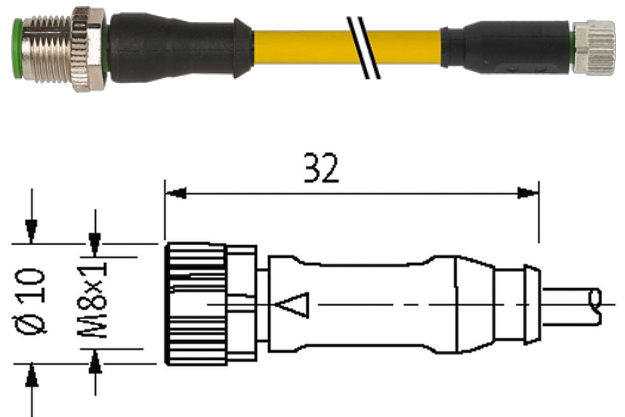
Illustration

Product may differ from Image

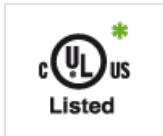
Approvals

cCSAus

* only for products with UL/CSA approved cable

Form

Form 40561

Cables

No./diameter of wires	3 x 0.25 mm ²
Wire isolation	PVC (br, bl, bk)
Jacket Color	yellow
Material (jacket)	PVC (UL/CSA)
Outer Ø	4.5 mm ±5%
Bend radius (moving)	10 x outer Ø
Temperature range (fixed)	-30...+80 °C
Temperature range (mobile)	-5...+80 °C
Cable identification	010
Cable Type	1 (PVC)
Approval (cable)	UL (AWM-Style 2464/1731), CSA
Cable weight [g/m]	29,37
Material (wire)	Cu wire, bare
Resistor (core)	max. 79 Ω/km (20 °C)
Single wire Ø (core)	0.15 mm

Construction (core)	14× 0.15 mm (multi-strand wire class 5)
Diameter (core)	3× 0.25 mm ²
AWG	similar to AWG 24
Material (wire isolation)	PVC
Material property (wire isolation)	CFC-, cadmium-, silicone- and lead-free
Shore hardness (wire isolation)	45 ±5 D
Wire-Ø incl. isolation	1.25 mm ±5%
Color/numbering of wires	br, bk, bl
Stranding combination	3 wires twisted
Shield	no
Material (jacket)	PVC
Material property (jacket)	CFC-, cadmium-, silicone- and lead-free
Shore hardness (jacket)	85 ±5 A
Outer-Ø (jacket)	4.5 mm ±5%
Color (jacket)	yellow
chemical resistance	good resistance to oil, gasoline and chemicals
thermal resistance	flame retardant UL 1581 VW1 / CSA FT1
Nominal voltage	UL 300 V AC
Test voltage	2000 V AC
Current load capacity	to DIN VDE 0298-4
Temperature range (fixed)	-30...+80 °C
Temperature range (mobile)	-5...+80 °C
Bend radius (fixed)	5× outer Ø
Bend radius (moving)	10× outer Ø

Technical Data

Operating voltage	max. 50 V AC/60 V DC
Operating voltage (only UL listed)	max. 30 V AC/DC
Rated surge voltage	1.5 kV
Operating current per contact	max. 4 A
Material group	IEC 60664-1, category I
Coding	A-coded
Locking of ports	Screw thread (M8/M12×1 mm) recommended torque 0.4/0.6 Nm, self-securing
Compression gland	M8 (SW9), M12 (SW13)
Protection	IP65, IP66K, IP67 inserted and tightened (EN 60529)
Locking material	Zinc die casting, matte nickel plated
Material	PUR
suitable for corrugated tube (internal Ø)	M12 (10 mm); M8 (6.5 mm)

General data

Standards	DIN EN 61076-2-101 (M12), DIN EN 61076-2-104 (M8)
Mounting method	inserted, tightened
Pollution Degree	3
Material (gasket)	FKM
Temperature range	-25...+85 °C, depending on cable quality

Commercial data

country of origin	DE
customs tariff number	85444290
EAN	4048879164405
eClass	27279218
Packaging unit	1

Sketch

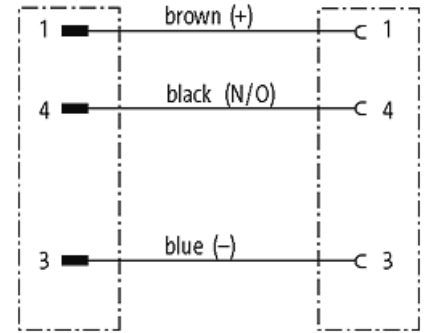

Male

Female

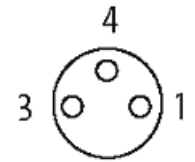
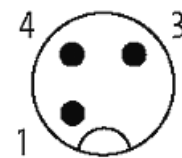

Product may differ from Image